







FOR YOUR SAFETY



The following pages explain how to avoid possible accidents and damage to the user and his property. They will explain the proper manner in which to use this product.

Explanation of caution indications

Caution	indication	Meaning
 Danger		Improper handling presents an immediate danger of death or serious injury.
 Warning		Improper handling may lead to death or serious injury.
 Caution		Improper handling presents a risk to physical health or property. *2

*1: injuries, skin burns, electric shocks, etc. not requiring hospitalization or extensive medical treatment.
*2: extensive damage to buildings and possessions; injury to domesticated animals and pets

Explanation of symbols

Symbol	Meaning of symbol
	This symbol indicates actions that must be strictly avoided. The details of the actions to be avoided are written in or around the symbol using graphics and/or text.
	This symbol indicates that there are procedures that must be followed without fail. The procedures to be followed are described in or around the symbol using graphics and/or text.
	This symbol indicates that the power plug must be disconnected from the socket. Details of the warning are written in or around the symbol using graphics and/or text.

Before using this product, please note that the manufacturer shall not assume any responsibility whatsoever for purely economic losses, such as lost communication opportunities, resulting from breakdowns, incorrect operation, product problems, or external causes such as power cuts.

Warning



Compulsory
This unit should only be used with a standard wall outlet 220VAC(DM-340MVZ) or 120VAC(DM-340MVT). If it is used in any other manner electric shock and fire could occur



Compulsory
Wash immediately with water if any liquid leaks from inside the unit and comes in contact with skin and/or clothes. It may irritate the skin and could stain clothing. If any liquid gets into the eye, wash immediately and contact a doctor. It may cause injury to the eye.



Compulsory
Never touch the chassis of the unit during use. The surface of the product may become very hot, especially the heat sink. A burn to the skin may occur.



Prohibited
Do not short-circuit the cables. Make sure the cables are connected to the correct terminal (Positive to positive and negative to negative).

ALINCO

DC POWER SUPPLY
DM-340MVZ/MVT

INSTRUCTION MANUAL

Thank you for purchasing the Alinco DC power supply, DM-340MVZ/MVT. The DM-340MVZ/MVT instruction manual contains important safety and operating instructions. Please read this manual carefully before using this product and keep the manual for future reference.

ALINCO,INC.



ALINCO,INC.

Shin-Dai Building 9th Floor
2-6,1-Chome, Dojimahama, Kita-ku, Osaka 530-0004, Japan
Phone:06-4797-2136 Fax:06-4797-2157
E-mail:export@alinco.co.jp

© Alinco, Inc., Osaka, Japan. All rights reserved.
Although Alinco has designed this manual to be as comprehensive and accurate as possible, we reserve right to make changes at any time to the contents or our specifications. Please note that certain products and accessories may not be available in a country of distribution. Please consult your Authorized Alinco Dealer for information.

PS0539
FNNJ-NL

Danger



Disassembly prohibited
Do not disassemble, modify or repair the unit unless otherwise specified in the manual. Only an authorized technician may do this. Never modify the cable to extend or shorten it. This may cause fire and/or electric shock, and will void the warranty.



Prohibited
Always hold the plug when plugging and unplugging the unit. Never unplug the unit by pulling the cable. It may cause fire, shock and damage to the unit.



Prohibited
Do not plug/unplug the unit with wet hands. It may easily cause electric shock.



Prohibited
Do not use the unit where there may be flammable gas. This may cause fire and explosion.



Prohibited
Unplug the cable when replacing the fuse. Use the specified fuse only. Using the wrong fuse could cause heat and fire.



Use in a wet place is prohibited
Never use the unit outside, in a bathroom, or any other place where the unit could become wet. Do not rest anything that contains liquid on the product. If liquid gets inside the unit it could cause fire, shock and damage to the unit. If this happens, unplug the unit immediately. Do not use the unit in a humid environment. If dew condenses on the unit, dry it completely before use.



Disconnect the power plug from the socket
Unplug the unit during maintenance. Otherwise it may cause shock and damage to the product.



Disconnect the power plug from the socket
Unplug immediately if anything noticeably unusual happens, such as smoke and/or strange odors coming from the unit. Contact our authorized service centers immediately for service.

Caution



Compulsory
Use this unit only in room temperatures (10 to 35 degrees centigrade or 50 to 95 degrees Fahrenheit). Keep the unit in a dry and well-ventilated place. Do not use the unit in direct sunlight, or where it may come in contact with water or in a poorly ventilated area. It may cause heat, fire and damage to the unit.



Prohibited
Never leave the unit within a child's reach. This may injure them or burn their skin.



Prohibited
Make sure that the devices that are to be connected meet the specifications of this unit, otherwise it may cause damage to the product(s).



Prohibited
Never insert any metal or flammable objects inside the unit. It may cause damage, shock and fire. If any foreign objects get into the unit, turn it off and unplug it and contact an authorized service center.



Compulsory
Place the unit on a secure and horizontal surface. If it is placed on an unstable surface, the unit may drop and cause damage and injury. This will also be helpful in getting accurate meter readings.



Prohibited
Do not cover the air vent on the chassis or the fan. This may cause extreme heat, fire and damage.



Prohibited
Do not use the unit for devices that require high current input at the start, such as motorized equipment. Do not use the unit to charge a car battery. This may cause damage to the unit.



Prohibited
Never try to use a car cigarette lighter in the cigarette lighter socket of this product. Otherwise, the product may become damaged.



Prohibited
Insert the cigarette-plug securely and completely into the socket. Insufficient connection may cause damage to the unit and/or connected devices.

INTRODUCTION

The Alinco **DM-340MVZ/340MVT** is designed and built to give years of solid, carefree service. The **DM-340MVZ/MVT** has over-current cut-off circuits providing D.C. protection. Then new compact size makes this the stoutest power supply in the small package available.

CAUTION

- When plugging the unit into a wall outlet, it must be turned off.
- Place the unit in a dry and well ventilated area.
- Never touch the unit while in use. Even though it is designed for high efficiency the unit will still get hot. If the unit reaches a certain temperature, the "extreme temperature protection" function will protect the unit by automatically dropping the current down to a safe level and the protection indicator will light up.
- A current limiting system will protect the unit from overloading.
- If a short circuit occurs at the output, the unit is protected by a short circuit protection function. Immediately turn off the unit and repair the cause of the short circuit then turn it back on.
- Do not use the unit for devices that require high current input at the start such as motorized equipment. Never use the unit to charge a car battery.
- Never use a car cigarette lighter in the cigarette plug socket on the unit.
- Before replacing a fuse make sure the unit is turned off. Be sure to use the specified type of fuse.
- Make sure the product is always suitably grounded to prevent electric shock and to reduce noise (The unit can be grounded by connecting a grounding cable to the appropriate screw).
- Never disassemble, modify, or touch the inside of the unit unnecessarily. This could cause damage to the product and will void the warranty.

OUTPUT VOLTAGE VS. MAX CURRENT(typ.)

The maximum output current changes in accordance with the output voltage setting. Please refer the diagram below.



SPECIFICATIONS

Input voltage: 220VAC 50/60Hz(340MVZ)
120VAC 50/60Hz(340MVT)
Output voltage: 1-15VDC variable
Output current: 30A continuous(at 13.8V)
35A max (50% Duty Cycle
1 min interval)
Output voltage regulation: less than 2%
Ripple voltage: less than 10mVp-p
Protection: Automatic current shut down(over 35A)
Fuse: 8A(340MVZ)/10A(340MVT)
Dimensions(W×H×D): 235mm×153mm×230mm
Weight: approx. 9.4kg

PART NAMES AND FUNCTIONS

- Power switch:** Turns the unit on and off.
- Voltage adjustment:** Adjusts voltage between 1.0 and 15.0 volts. Turn clockwise to increase and counter-clockwise to decrease the voltage. When it is set at the center position it will supply 13.8 volts.
- Power indicator:** Lights up when the unit is turned on.
- Voltage meter:** Displays the voltage.
- Current meter:** Displays the current.

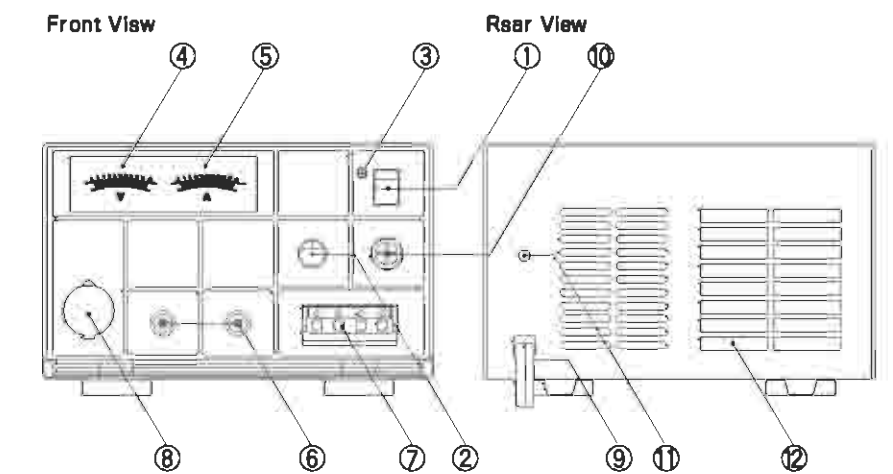

- Output terminal:** 35A max. Red positive, black negative.
- Snap in output terminal:** 6A max. Red positive, black negative.
- Cigarette plug terminal:** 10A max.
- Power cable:** 220VAC(340MVZ)/120VAC(340MVT).
- Fuse:** 8A(340MVZ)/10A(340MVT).
- Grounding screw:** Used to connect the Earth grounding cable to the unit.
- Cooling fan:** The fan turns on and off automatically.