



ALINCO, INC.

Head Office: Shin-Dai Building 9th Floor
2-6-1 Dojimahama, Kita-ku, Osaka 530-0004, Japan
Phone: +81-6-4797-2136 Fax: +81-6-4797-2157
E-mail: export@alinco.co.jp

PS0483

ALINCO

VHF/UHF FM TRANSCEIVER

DJ-C6 T/E

Instruction Manual

Thank you for purchasing this ALINCO transceiver.
This instruction manual contains important safety and
operation instructions.
Please read it carefully before using the transceiver
and be sure to keep it for future reference.

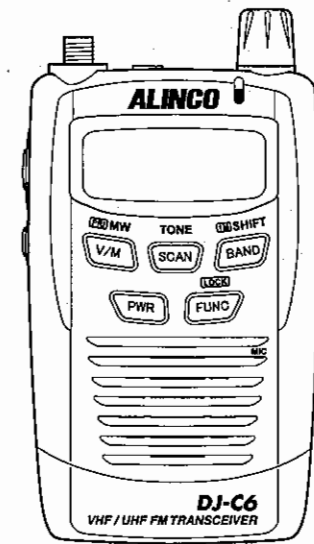

ALINCO, INC.

NOTICE / Compliance Information Statement



In case the unit you have purchased is marked with a CE symbol, a copy of the relative conformity certificate or document can be reviewed at <http://www.alinco.com/usa.html>. See the back cover for more details.

MANUFACTURER: ALINCO, INC. Shin-Dai Building 9th Floor 2-6-1 Dojimahama, Kita-ku, Osaka 530-0004, Japan
 Copyright © 2005 All rights reserved. No part of this document may be reproduced, copied, translated or transcribed in any form or by any means without the prior written permission of Alinco, Inc., Osaka, Japan. English Edition Printed in Japan.

VHF/UHF FM HANDHELD TRANSCEIVER DJ-C6E 144.000 - 145.995MHz / 430.000 - 439.995MHz
 This device is authorized for use in all EU and EFTA member states.
 An Operator's license is required for this device.

CE0336

Contents

Before Operating the Transceiver.....	6	4.6 Memory Mode.....	16
Attention.....	5	■Types of Memory.....	16
Points to Note Before Transmitting.....	5	■Programming a Memory Channel.....	16
Points to Note When Using an External Power Supply.....	5	■Selecting a Memory Channel.....	16
1. Functions and Features.....	6	■Clearing a Memory Channel.....	17
1.1 Standard Accessories.....	6	■Contents of Memory Channel.....	17
2. Accessories.....	6	4.7 Receiving.....	18
2.1 Attaching Accessories.....	6	■Monitoring.....	18
■Connecting and Disconnecting the Antenna.....	6	4.8 Transmitting.....	18
■Attaching and Detaching the Battery Pack.....	7	5. Advanced Operations.....	19
■Preventing Short Circuiting the Battery Pack.....	8	5.1 Scanning.....	19
■AC Battery Charger (EDC-126/126).....	8	■VFO Scan.....	19
■Low Battery Indicator.....	8	■Program Scan.....	19
3. Control Functions.....	9	■Memory Scan.....	20
3.1 Name and Operation of Transceiver Controls.....	9	5.2 Keylock.....	20
■Top and Front Views.....	9	5.3 Tone Burst.....	20
■Side View.....	10	5.4 Priority.....	21
3.2 Keypad.....	11	5.5 Tone Squelch and Related Functions.....	21
3.3 Display.....	12	5.6 Tone Scan.....	22
4. Basic Operations.....	13	5.7 Shift / Split Function.....	22
4.1 Turning the Power ON.....	13	6. Parameter Setting Mode.....	23
4.2 Adjusting the Audio Volume.....	13	6.1 Mode Setting Items.....	23
4.3 Adjusting the Squelch.....	14	6.2 Selecting the Setting Mode.....	23
4.4 Operating Modes.....	14	6.3 Selecting the Parameters.....	24
■Switching Between Modes.....	14	(1) Audio Volume Level.....	24
4.5 VFO Mode.....	15	(2) Repeater function.....	24
■Switching the Band.....	15	(3) Tone Burst Frequency.....	24
■1MHz UP/DOWN.....	15	(4) APO (Auto Power Off).....	24
■Entry Completion Digit for Different Tuning Steps.....	15	(5) Battery Save function.....	25
		(6) BEEP Sound.....	25
		(7) BELL.....	25
		(8) Memory Write Protect function.....	25
		(9) Scan Type.....	26
		(10) AM / FM.....	26

7. Cloning	27
7.1 Cloning	27
■ Connecting the Transceiver	27
■ Receiving the Master Data	27
■ Transmitting Data from the Master Transceiver	27
8. Maintenance and Reference	29
8.1 Troubleshooting	29
8.2 Resetting	30
8.3 Options	30
8.4 Transmission System	31
9. Specifications	32

Before Operating the Transceiver

Attention

- Do not open the case or touch the interior components. Tampering can damage the equipment.
- Do not expose the transceiver to direct sunlight, dusty places or place it near sources of heat.
- Keep the transceiver away from TVs, tuners or other equipment if it interferes with reception.
- Securely connect the antenna included with the transceiver.
- When transmitting for a long time, the transceiver can overheat.
- Turn the power off immediately if the transceiver emits smoke or strange odors. Ensure that the transceiver is safe, then bring it to the nearest Alinco Service Center.

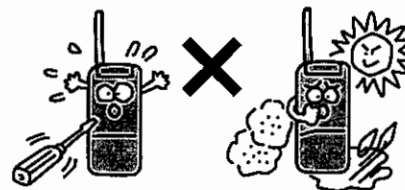

Points to Note Before Transmitting

Many wireless stations use frequencies adjacent to the ham bands for business purposes. Be mindful when transmitting near them. Even when amateur stations obey regulations, unexpected interference can occur. Pay sufficient attention during mobile operation.

⚠ Caution

The use of a transceiver in the following places may be prohibited:

- Aboard aircraft
- In airports
- In shipping ports
- Within or near the operating area of business wireless stations or their relay stations.

Before using in any of the above places, obtain any necessary permissions from the proper authorities, and be mindful of local laws that govern amateur radio operation.

Points to Note When Using an External Power Supply

- Use a regulated 3.7V - 6.0V DC external power supply.
- To charge the battery or operate the transceiver using AC power, use AC adaptor (EDC-126 or EDC-128 depending on the version*).
- When power is supplied from the cigarette socket of a car, use cigarette lighter cable (EDH-32).
- Turn the transceiver's power off when connecting or disconnecting the DC cable.

* This adaptor has been designed as a battery charger. A noise may occur in RX/TX signals. The noise won't harm the transceiver and is not a defect. Use of a regulated power supply is recommended.

1. Functions and Features

- 39 CTCSS tone squelch settings
- Tone burst function (1000, 1450, 1750 and 2100Hz)
- Split function
- Cloning
- Li-ion Battery adoption
- SMA antenna port
- Auto-repeater setting

1.1 Standard Accessories

- Li-ion Battery Pack EBP-58N (3.7V 600mAh)
- AC battery charger (EDC-126 or 128: 6.0V 0.5A)
- SMA Antenna
- Antenna Cap
- Instruction Manual

*Standard accessories may differ depending on the version.

2. Accessories

2.1 Attaching the Accessories

■ Connecting and Disconnecting the Antenna

● Connecting

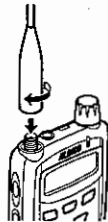

1. Connect the SMA antenna to the antenna connector at the upper left corner.
2. Hold the SMA antenna by its base, and turn it clockwise until it stops.

● Disconnecting

To disconnect the antenna, turn it counter-clockwise.

■ Attaching and Detaching the Battery Pack

● Attaching

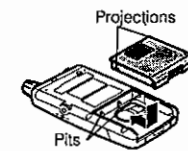

1. Align the projections on the battery pack with the pits on the transceiver.
2. Push in the direction of the arrow until the latch clicks.



● Detaching

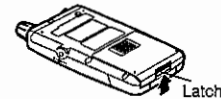

1. Push the latch upward.

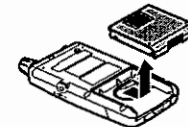

2. Pull out the battery pack in the direction of the arrow shown left.

⚠ Caution

- The battery pack is not charged when shipped. It must be charged before using.
- The battery pack can be charged by mounting it on the DJ-C6 and connecting AC battery charger to the DC power supply jack on the transceiver.
- It takes up to 2 hours and 30 minutes (maximum) to fully charge the battery pack.
- Charging should be conducted within a temperature range of 0 to 40°C (32 to 104°F).
- Do not modify, dismantle, incinerate, or immerse the battery pack in water, as these practices can be dangerous.
- Never short-circuit the battery pack terminals, as this can cause damage to the equipment or lead to overheating the battery, which could cause burns.
- Please be sure to remove the battery pack when the transceiver is not in use.
- The battery pack should be stored in a dry place where the temperature range is between -20 to 45°C (-4 to 113°F).
- Typically, the battery pack can be charged up to 500 times. However, the battery pack can be considered consumed if the period of use drops significantly despite the pack being charged for the aforementioned charging time. When this happens, a new pack should be used.
- In the interests of environmental protection, do not dispose of the used battery pack improperly. Check with your local solid waste officials for details on recycling options or proper disposal in your area.

⚠ Caution

When carrying

- Do not carry the DJ-C6 in the pants pocket. It may damage the transceiver when you sit.
- The DJ-C6 has been tested for anti-shock and/or against drops for daily use, but does not comply with military-specs. Please be careful not to drop it or subject it to excessive stress/shocks.

Preventing Short Circuiting the Battery Pack



Be extra cautious when carrying the battery pack; short-circuiting will produce surge current possibly resulting in fire.

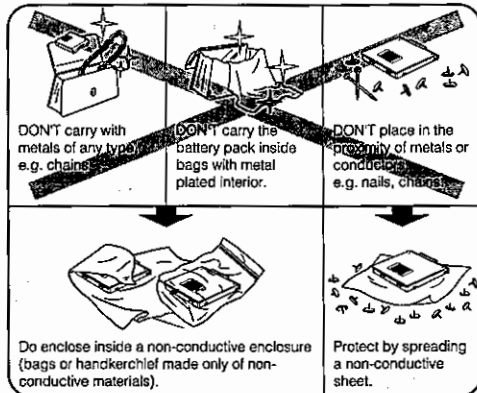

DON'T carry with metals of any type e.g. chains

DON'T carry the battery pack inside bags with metal plated interior.

DON'T place in the proximity of metals or conductive objects e.g. nails, chains

Do enclose inside a non-conductive enclosure (bags or handkerchiefs made only of non-conductive materials).

Protect by spreading a non-conductive sheet.

AC Battery Charger (EDC-126/128)

Recharging

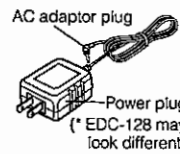

1. Mount the battery pack on the transceiver.
2. Connect AC adaptor plug to the external power supply jack on the transceiver.
3. Connect the power plug to an outlet.

Regardless of whether the power switch of the transceiver is on or off, it will start charging. Low battery Indicator shown below blinks and the TX/RX lamp illuminates red during charge when the transceiver is off. Once it is fully charged, the TX/RX lamp will turn green.

Caution

- Be sure to connect the charger to the battery pack after mounting it to the transceiver. Otherwise, the battery pack won't be recharged.
- Disconnect the charger from the outlet while not using it.
- Never charge the battery packs of other manufacturers with this charger.
- The required charging time depends on the condition of the battery pack.
- Never short-circuit the terminals of the battery pack with metal objects and the like. Both this charger and the transceiver could be damaged.
- The charger does not work when the voltage from an outlet is extremely low.

Low Battery Indicator

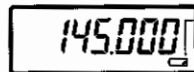

Low Battery Indicator
The charge level is low.

- Battery consumption level may change depending on the surrounding temperature or the frequency of use.
- Charge the battery when the Low Battery Indicator appears.
- The Low Battery Indicator is not an indicator for battery life remaining.

3. Control Functions

3.1 Name and Operation of Transceiver Controls

Top and Front Views

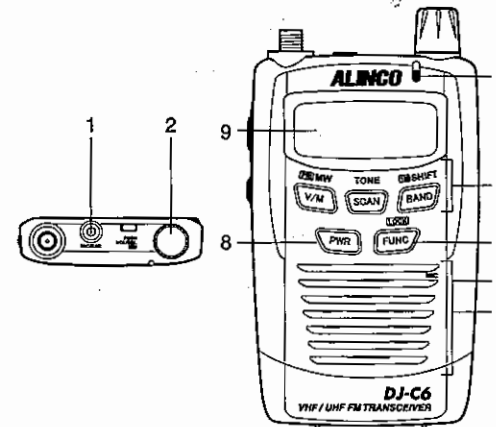

Item	Description
1	SP/MIC Connector For connection of the optional external speaker (8Ω) and microphone (2kΩ) with 2.5φ stereo plug.
2	Dial Rotate this dial to select transmitting / receiving frequency, memory channel, and other functions. When you press it down, you can change the volume or squelch level, or select options in the Setting mode while the icon appears. (See on P.11)
3	TX/RX Lamp It illuminates green when the squelch unmutes, red when transmitting.
4	Keypad It commands various operations. (See on P.11)
5	FUNC Key Use this key in combination with other keys to access various functions of the transceiver. Holding this key for 1 second activates the Keylock setting.
6	Microphone Speak into microphone from a distance of Approx. 5 cm.
7	Speaker This is a thin built-in speaker.
8	Power Key Turn the power on/off.
9	Display (LCD) Refer to "Display" in this manual. (See on P.12)

Side View

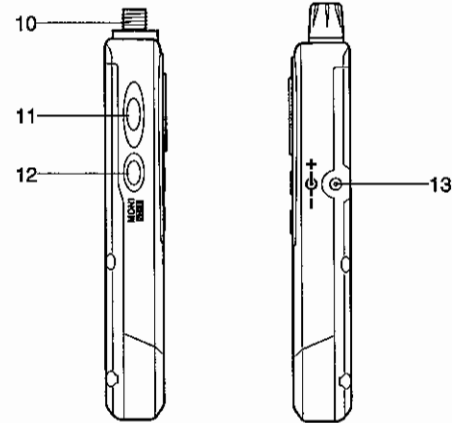

Item	Description
10	SMA Antenna Connector For connection of the included SMA antenna. If you use another antenna, choose one with a low SWR (Standing Wave Ratio) designed for VHF and UHF frequencies.
11	PTT Key Press this key to transmit. When the key is released, the transceiver returns to the receiving mode.
12	MONI Key When this key is pressed, the squelch is unmuted and you can hear the received signal. The squelch is also unmuted when TSO is set. (See on P.18) If this key is pressed while the  icon appears, you can change the tuning step. (See on P.15)
13	DC-IN Jack This is for connecting an external power supply. By connecting included AC adaptor, you can charge the battery. By connecting an optional cigarette lighter cable (EDH-32), you can supply power from a car and charge the battery.

3.2 Keypad



Key	Independent Operation	Press FUNC While It's ON	Press Key for 1 Sec	Dial Operation While Holding Key
V/M	Switches between the VFO and Memory mode. (See on P.14)	Programs to memory channels. (See on P.16)	Starts the Priority monitoring function. (See on P.21)	
SCAN	Starts and stops scanning. (See on P.19-20)	Sets the Tone Squelch setting. (See on P.21-22)		Switches the VFO/Program /Tone scan.
BAND	Switches among bands. (See on P.15)	Sets the Shift setting. (See on P.22)		Adjusts frequency in 1 MHz units. (See on P.15)
FUNC	Switches among functions.		Switches ON/OFF the Keylock function. (See on P.20)	
PWR	Turns power ON/OFF. (See on P.13)	Resets the transceiver to factory defaults.		
Dial	Adjusts volume, squelch, and other parameters/values. (See on P.13,14,23)	Enters the Setting mode. (See on P.23)		

3.3 Display

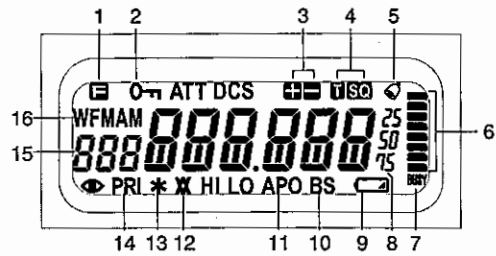

1		Appears when the FUNC key is pressed.	9		Appears when the charge level is low.
2		Appears when keys are locked.	10	BS	Appears when the battery save function is on.
3		Indicates the shift (+/-) direction or split operation.	11	APO	Appears when the auto power off function is activated.
4	T SQ	Appears when the tone squelch is set.	12	X	Appears when the reverse tone squelch is set.
5		Appears when the bell function is on.	13	*	Appears when the repeater mode is on.
6		Indicates received signal level and the transmission output.	14	PRI	Appears when the priority monitoring function is on.
7	BUSY	Appears when the squelch is unmuted.	15	888	Indicates memory channel No. and other setting status.
8	888.888	Indicates the frequency and status of various settings.	16	AM	Indicates the AM receiving mode.

Other icons which are not mentioned in the table are not used with the DJ-C6.

4. Basic Operations

4.1 Turning the Power ON



Hold the **PTT** key down for a second.

To turn the power OFF, hold the **PTT** key down until the display turns off.

Caution

If the external power supply is over 6.5 volts, "dC-over" is displayed on the LCD with the red and green LEDs alternately blinking. If this occurs, disconnect the external power supply jack from the transceiver immediately. Otherwise the transceiver will be damaged. Note that no warnings are displayed on the LCD if the external power supply exceeds 6.5 volts when the transceiver is ON. Application of a voltage of over 10 volts will damage this transceiver. Never use the AC adaptor cable of other manufacturers.

4.2 Adjusting the Audio Volume

- There are 31 volume levels. (00-30)
- Default is set to 10.

1. Press the dial once. "VOL - 10" will be displayed on the LCD indicating the present volume level.



2. Adjust the volume level by rotating the dial. As the value increases, the sound becomes louder.
3. Press the dial again or the PTT key to complete the setting and to return to the operating mode. It also returns to the operating mode when no dial operations are made for 5 seconds.

Caution

When you use an earphone, be sure to set the volume to a proper level. Also, the Audio Volume Level in the Setting mode should be set to LOW. For more information, please refer to "Audio Volume Level" on P.24.

4.3 Adjusting the Squelch

The squelch is a function for eliminating noise when no signals are present. "To open the squelch" means that the DJ-C6 monitors any signals stronger than the squelch level you set.

- There are 10 squelch levels. (0-9)
- Default is set to 3.

1. Press the dial twice. "59L - 3" will be displayed on the LCD indicating the present squelch level.



2. Adjust the squelch level by rotating the dial. When you set it to a higher level, weak signals would be interrupted while monitoring or would not be monitored at all. Generally, you should set the squelch to the lowest level where noise would be eliminated. Depending on the monitored frequencies and the conditions of the circumstances around you, the squelch level may need to be adjusted.

3. Press the dial again or the PTT key to complete the setting and to return to the operating mode. It also returns to the operating mode when no dial operations are made for 5 seconds.

4.4 Operating Modes

The DJ-C6 has two operating modes; VFO mode and Memory (MR) mode.

Switching Between Modes

Every time you press the key, the operating mode can be switched between these two. When you switch to the Memory mode, the memory number will be displayed on the LCD.

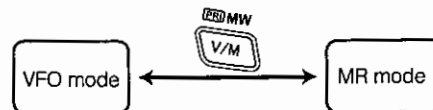

Tip
When there are no programmed memory channels, it can't be switched to the Memory mode.

4.5 VFO Mode

This is the mode which is set as the factory-shipped configuration. Radio frequencies and various settings can be changed by rotating the dial in this mode.

Switching the Band

Every time you press the key, the bands listed below can be switched in order.

Default	VHF	DJ-C6T: 145.000 (142.000-173.995MHz)	FM
		DJ-C6E: 145.000 (144.000-145.995MHz)	
	L-UHF	DJ-C6T: 380.000 (380.000-419.995MHz)	FM
		DJ-C6E: 380.000 (380.000-419.995MHz)	
	H-UHF	DJ-C6T: 445.000 (420.000-511.995MHz)	FM
		DJ-C6E: 433.000 (430.000-439.995MHz)	
	Air Band	DJ-C6T: 118.000 (108.000-141.995MHz)	AM/FM

1 MHz UP/DOWN

When you rotate the dial with holding the key down, you can increase or decrease a frequency by a 1MHz-step in accordance with the direction of dial rotation. This function is a quick way to increase or decrease the frequency by a large amount.

After pressing the key, releasing it without any dial operations can switch among bands.

Entry Completion Digit for Different Tuning Steps

The tuning step can be changed. You may choose one of the selections as follows:
Auto, 5, 6.25, 8.33, 10, 12.5, 15, 20, 25, 30, 50, 100, 125, 200 kHz.

1. Press the key to select the band to change its tuning step.
2. Press the key, and press the MONI key when you see the icon appears on the LCD.
3. Rotate the dial to choose a tuning step as you desire.
4. Press the PTT key to complete the setting and to return to the operating mode.

The default tuning step is set to "Auto". Choosing any tuning step but "Auto" in any of the bands releases the default setting to "Auto" in all provided band selections, and the last selected tuning step for a specified band is programmed. Returning the setting to "Auto" in a specified band, all tuning steps for all provided bands will be returned to "Auto". "Auto" uses tuning steps and modes which are programmed into the DJ-C6 at the factory.

4.6 Memory Mode

This mode allows you to program frequencies into the DJ-C6 memory. A programmed frequency is called a channel. The DJ-C6 has four types of memory functions; Memory channel (general), Program scan channel, Priority channel, and VFO auto programmed channel.

Types of Memory



Memory channel (general) (0-199)	This is a channel which is called up in the Memory mode. You may program up to 200 channels in the DJ-C6. When you program frequently used frequencies in advance, you can easily select whatever you wish to use.
Program scan channel (0A, 0b-4A, 4b)	This is a channel which is used for the Program scanning function. You can program up to 5 pairs of frequency ranges (higher and lower limits). (See on P.19)
Priority channel (PRI)	This is a channel which is used for the Priority monitoring function. (See on P.21)
VFO auto programmed channel (AH, AL)	This is a channel which is used for the Repeater function. You can program a pair of frequency ranges (higher and lower limit) to apply settings for the repeater automatically. Refer to "(3) Repeater function" on P.24 for setting/operation detail.

Programming a Memory Channel

- In the VFO mode, adjust the frequency you wish to program by rotating the dial.
- Set the Shift (+/-) and/or Split settings, if necessary. For more information on these settings, please refer to "Shift / Split Functions" on P.22.

- Press the  key to display a memory channel number on the LCD, and select a channel you wish to write to by rotating the dial.

The blank channels will blink and programmed channels will remain lit up.

- Press the  key while the  icon appears on the LCD.

A beep sounds telling you that the frequency is written to the memory channel successfully.

Tip

To overwrite to an already-existing memory channel, be sure that the Memory Write Protect function is set to OFF. For more information on this function, please refer to "Memory Write Protect function" on P.26.

Selecting a Memory Channel

- Press the  key to switch to the Memory mode. A memory channel number will be displayed on the LCD.

Caution





When nothing is written to any memory channel, it can't be switched to the Memory mode.





- Rotate the dial to select the memory channel number you wish to call up.

Clockwise rotation: Each click increases the memory channel number by one.
Counter-clockwise rotation: Each click decreases the memory channel number by one.



Clearing a Memory Channel

- Set the Memory Write Protect function to OFF, if necessary. For more information on this function, please refer to "Memory Write Protect function" on P.26.
- Press the  key to switch to the Memory mode.
- Rotate the dial to select the memory channel number you wish to delete.
- Press the  key, and press the  key while the  icon appears on the LCD. A beep sounds telling that the frequency is deleted successfully, and "-----" is displayed on the LCD.
- With "-----" displayed on the LCD, rotate the dial to return to the Memory mode.

Press the  key to return to the VFO mode.

When there are no programmed memory channels, press the  key to return to the VFO mode.

Tip

Right after deleting the memory channel with "-----" displayed on the LCD, you can restore what you erased. To restore the channel, press the  key and press the  key again while the  icon appears on the LCD. Note that you won't be able to restore it once you change the operating mode.

Contents of Memory Channel

The following settings can be stored in each memory channel:

- Frequency
- Shift frequency
- Shift direction (+/-) and Split setting
- Tone encoder frequency
- Tone decoder frequency
- Tone encode/decode setting
- Mode (AM/FM)

4.7 Receiving

1. Adjust the volume level. (See on P.13)
2. Adjust the squelch level. (See on P.14)
3. Select the frequency on which you wish to receive signals.

When a signal is received on the frequency you selected, the **BUSY** icon will appear at the lower right of the LCD, and signal level indicators are displayed according to the strength of received signals as well. Also, the green TX/RX indicator will light when a signal is received.

■Monitoring

This function can be used to temporarily release the squelch level setting you set when the received signal is too weak to monitor or is interrupted during monitoring.

- The squelch is unmuted (is opened completely) while the MONI key is held down, regardless of the squelch level setting.
- This function unmutes (opens completely) the squelch even when the Tone Squelch function is set.

4.8 Transmitting

1. Select a frequency on which you wish to transmit signals.
2. Press the PTT key.
When the red TX indicator lights, you are transmitting.
3. While holding the PTT key down, speak toward the microphone on the transceiver at normal speaking volume.
4. Release the PTT key when you finish speaking.
It returns to a receiving or monitoring state.

⚠Caution

- Pressing the PTT key outside the transmission frequency range displays "FF" on the LCD. Transmission is not possible in this state.
- Note that the receiving and transmitting frequencies are different when you set the Shift direction and/or Split setting.

📄Tip

Available transmitting frequency ranges:
 VHF... 144.000-147.995 MHz (DJ-C6T)
 144.000-145.995 MHz (DJ-C6E)
 UHF... 420.000-449.995 MHz (DJ-C6E)
 430.000-439.995 MHz (DJ-C6E)

5. Advanced Operations

5.1 Scanning

This function automatically searches for active frequencies to help you locate a signal that you wish to receive. There are two types of scanning; Busy scan and Timer scan. The default is set to Busy ("BUSY") scan. Switching between those two types can be done in the Setting mode. (See on P.26)

Busy scan:

If no signal is monitored after scanning stops, it will search for another frequency.



Timer scan:

Even if a signal is detected after scanning stops, it will resume scanning after 5 seconds.

- While it is scanning, the decimal point (.) on the LCD blinks.
- Even when it is scanning, a scan will be suspended and the squelch will open temporarily when you hold the MONI key down. Scanning will continue when you release the MONI key.
- While it is scanning, the scanning direction can be changed with a dial operation. Scanning starts in the direction of the last dial operation (up or down).
- Press any key other than the MONI key to stop scanning.

■VFO Scan

In the VFO mode, scanning is performed to detect signals using the tuning step you set in advance (see on P.15) for any frequencies in the specified band.

1. Press the  key to switch to the VFO mode.
2. While holding the  key down, rotate the dial to display "vFo" on the LCD.

3. Release the  key.

Scanning will be performed with the selected tuning step in the direction of the last dial operation (up or down).

4. Rotate the dial in the clockwise direction to scan in the UP direction. Conversely, rotate the dial in the counter-clockwise direction to scan in the DOWN direction.



5. Press any key other than the MONI key to stop scanning.

■Program Scan

Scanning is performed to detect signals between a specified range of frequencies. Both the higher and lower limit of the scan range need to be set in advance. Otherwise, the following operations can't be done.

A programmed pair of frequencies (higher and lower limit) is called a "program scan channel". You can program up to 5 pairs of frequency ranges.

For more information on how to program, please refer to "Programming a Memory Channel" on P.16.

1. Press the  key to switch to the VFO mode.
2. While holding the  key down, rotate the dial to select a program scan channel, such as P0A and P0b, to search.

3. Release the  key.

When you have selected "A" side, scanning will be performed in the direction of side "b".

Conversely, when you have selected "b" side, scanning will be performed in the direction of side "A".

Whichever you choose, it scans within the same range.

4. Rotate the dial in the clockwise direction to scan in the UP direction.
Conversely, rotate the dial in the counter-clockwise direction to scan in the DOWN direction.

5. Press any key other than the MONI key to stop scanning.

Memory Scan

Scanning is performed to detect signals among frequencies programmed as the memory channels. Memory channels need to be set in advance. Otherwise, the following operations can't be done.

For more information on how to program, please refer to "Programming a Memory Channel" on P.16.

1. Press the  key to switch to the Memory mode.

2. Press the  key.
"mEmorY" is displayed on the LCD.

3. Release the  key.
Scanning will be performed.

4. Rotate the dial in the clockwise direction to scan in the UP direction.
Conversely, rotate the dial in the counter-clockwise direction to scan in the DOWN direction.

5. Press any key other than the MONI key to stop scanning.



Tip

With the DJ-C6 the "Memory Skip" function, which excludes specified channels during a scan, or the "Memory Bank" function, which divides channels into several groups, is NOT available.

5.2 Keylock

The keylock function avoids unwanted, incorrect, or unauthorized operation of the keys.

The following can be done even when the keylock function is ON:

- Receiving signals with the MONI key held down
- Transmitting with the PTT key held down
- Adjusting the volume and squelch level
- Turning the power ON/OFF
- Canceling the keylock
- MONI (monitor) function

1. Hold the  key for a second to switch ON/OFF the keylock function.

When the keylock function is ON, the  icon will appear on the LCD.

5.3 Tone Burst

The Tone Burst function is used to call up another station or to activate a repeater by adding a tone signal to the transmitted signal.

While transmitting, press the  key to transmit the tone burst signal. The default frequency of the tone signal is 1750-Hz, and it can be changed in the Setting mode. (See on P.25) The CTCSS can be used with the tone burst.

5.4 Priority

This function monitors two frequencies alternately to increase efficiency for receiving signals.

Every 5 seconds, the DJ-C6 momentarily switches from the specified frequency to the frequency which is programmed as the priority channel (see on P.16) for 0.5 seconds.

1. Hold the  key down for a second to start the Priority monitoring function.
The PRI icon will appear on the LCD.



2. Press the  key again to release this function.
The PRI icon disappears.



Tip



- You are required to program a priority channel in advance. Otherwise, a beep sounds and the above operations can't be done. For more information on how to program, please refer to "Programming a Memory Channel" on P.16.
- Scanning is not available during the Priority monitoring.
- Even if a signal is received on the priority channel, it returns to the specified frequency after a lapse of 5 seconds.
- You can specify a frequency in either the VFO mode or one of the memory channels (general).

5.5 Tone Squelch and Related Functions

The Tone Squelch (The  and the  icons appear on the LCD when it is active) is a function to unmute (open) squelch only when one of the tone (encoder) frequencies you set matches the decoding tone setting of another station.

When you set a decoder frequency the same as that of another station, you will only hear stations using the same encode/decode settings.



This function allows you to communicate with specific stations easily without listening to unwanted signals.

1. Press the  key, and press the  key while the  icon appears on the LCD.

Both the  icon and a tone frequency are displayed on the LCD. The tone encoder function is now ready to set.

2. Rotate the dial to adjust to the tone encoder frequency. If you wish just to activate a repeater without the Tone Squelch setting, press the PTT key or wait 5 seconds to complete the setting. Also, go on to "Shift / Split Function" on P.22. Otherwise, follow the steps below.

3. Press the  key while the tone encoder frequency is displayed on the LCD.





The  icon, the  icon, and the programmed tone encoder frequency are displayed on the LCD. The tone encoder/decoder function (Tone Squelch) is now ready to set.

4. Rotate the dial to adjust to the tone decoder frequency. It is possible to set the tone encoder and the tone decoder frequency independently. Change the decoder value if the system requires the differentiate encode/decode tones.

5. Press the PTT key or wait 5 seconds to complete the setting.
The Tone Squelch setting will be complete.

6. To deactivate the Tone Squelch function, repeat steps

1 to 4, and press the  key during step 4.



After the  icon* is displayed, press the  key again to display "OFF". With the OFF state, press the PTT key or wait 5 seconds to deactivate the Tone Squelch function. The  and  icon disappear.

* See the following for details.

7. While the icon is displayed on the LCD during the setting, press the PTT key or wait 5 seconds to perform the Reverse Tone Squelch.

The Reverse Tone Squelch (the  icon is displayed on the LCD when it is set) is a function to mute (close) the squelch only when the DJ-C6 receives a frequency matching the programmed encoder frequency.

It unmutes (opens) the squelch when the DJ-C6 receives a frequency unmatching the programmed encoder frequency. This function is not generally used in ham radio operation.

To release the Reverse Tone Squelch function, press the  key to display "OFF" on the LCD then press the PTT key while the  icon is displayed.

5.6 Tone Scan

This function detects the CTCSS tone frequency automatically from a received signal.

1. In the VFO mode, rotate the dial to tune to a frequency on which a tone signal is transmitted.

2. While holding the  key down, rotate the dial to display "tonE" on the LCD.

3. Release the key.

The Tone Scan function will be activated. Tone frequencies are displayed on the LCD constantly.

Once the DJ-C6 finds a tone, a beep sounds and the Tone Scan stops.

The found tone is programmed as a decoder frequency automatically.

4. Press the key to return to the VFO mode.

This function continues searching for a tone until it detects one. Press the same key to quit or suspend temporarily.

5.7 Shift / Split Function



This function is usually used when you communicate via repeater.

Shift function:

It functions to shift to a transmitting frequency from a receiving frequency.

Split function:

It functions to receive signals in the VFO mode and to transmit signals in the Memory mode, or vice versa. This function is convenient for the cross-band repeater access.

1. Press the  key. Every time you press the  key while the  icon appears on the LCD, the display indication will be changed as follows:

Shift frequency -> Shift frequency -> Shift frequency -> "SPLit"

Caution

When a transmitting frequency is out of transmitting range after the Shift / Split function is set, "OFF" is displayed on the LCD while the PTT key is pressed. If this occurs, check the shift value/direction and correct it.



6. Parameter Setting Mode

The DJ-C6's Setting mode is used to set the various operating parameters.

6.1 Mode Setting Items

- (1) Audio Volume Level
- (2) Repeater function
- (3) Tone Burst Frequency
- (4) APO (Auto Power Off)
- (5) Battery Save function
- (6) BEEP Sound
- (7) BELL
- (8) Memory Write Protect function
- (9) Scan Type
- (10) AM / FM

6.2 Selecting the Setting Mode

1. Press the  key, and press the dial once while the  icon appears on the LCD. It switches to the Setting mode, and the menu will be displayed on the LCD.

2. Select an item by pressing the dial.

Every time you press the dial, the displayed menu is changed. When you press the MONI key, the menu are displayed in reverse direction.

3. When the item to be configured is displayed on the LCD, change a value or a setting by rotating the dial.

4. Press the PTT key to complete the setting.

6.3 Selecting the Parameters

The following 11 functions can be set in the DJ-C6's Setting mode.

(1) Audio Volume Level

When you use an earphone, you may reduce the entire audio level with this function if the volume is too loud.

1. "HivLUmE" is displayed on the LCD.
2. Rotate the dial to select HIGH/LOW volume level as follows:

"HivLUmE" -> "LovLUmE"

Caution

Never change the setting while you are wearing the earphone. Your ear may be hurt by extremely loud noise.

(2) Repeater function

With this function on, when you enter to the range set by AL-AH memories, the preprogrammed repeater-parameters will be applied automatically.

1. Prior to set this parameter, edit a lower limit frequency (the shift direction and the CTCSS tone if required) in the VFO mode and store it to AL memory channel.
2. Edit a higher limit frequency to AH memory channel.
3. Enter to the Setting mode and select "rPt".
4. Rotate the dial to switch ON/OFF the Repeater function.
When you set it to ON, the * icon will appear on the LCD.

Tip

Please deactivate the shift/tone setting in the VFO mode to operate the Repeater function. The manual settings have priority. This setting is valid for either VHF or UHF band.

(3) Tone Burst Frequency

1. "1750" is displayed on the LCD.
2. Rotate the dial to select the Tone Burst Frequency setting as follows:

"1750" -> "2100" -> "1000" -> "1450"

(4) APO (Auto Power Off)

This function automatically turns the power OFF if there is no key operation for a specified period of time to prevent wasting the battery charge.

1. "offAPO" is displayed on the LCD.
2. Rotate the dial to select a setting value as follows:

"OFF" -> "30" -> "60" -> "90"

Just before cutting the power OFF, a beep will be heard. Select the time from 30, 60, 90 minutes, and OFF. When OFF is selected, this function does not work.

To turn the power ON, press the POWER (PWR) key again.

Tip

With this function ON, even if the DJ-C6 receives signals, it won't reset the turn-off time. Only key operations will extend it.

(5) Battery Save function

This function prevents wasting battery power by switching the reception circuit power supply OFF.

With this function ON, the transceiver will be in a hibernation state if there is no key operation or received signals for a continuous period of 5 seconds.

1. "bS" is displayed on the LCD.
2. Rotate the dial to switch ON/OFF the Battery Save function.
When you set it to ON, the BS icon will appear on the LCD.

- The factory-shipped default is set to ON.
- This function will be released temporarily when the DJ-C6 receives signals or there is a key operation.
- This function will not be performed while the DJ-C6 is under scanning.
- LCD remains active even when the Battery Save function is ON.

(6) BEEP Sound

This function sounds a beep during operations. If you feel it is noisy or annoying, you may turn off the sound.

1. "offBEEP" is displayed on the LCD.
2. Rotate the dial to switch ON/OFF the BEEP Sound as follows:

"offBEEP" -> "onBEEP"

(7) BELL

It functions like a pager. The DJ-C6 tells you with a bell sound that another station is calling.

1. "bELL" is displayed on the LCD.
2. Rotate the dial to switch ON/OFF the bell function.
When you set it to ON, the bell icon will appear on the LCD.

When the DJ-C6 receives signals, the bell icon will blink on the LCD and a bell sounds.
To stop the bell sound, press the PTT key.

(8) Memory Write Protect function

This function prevents overwriting or deleting memory channels by mistake and protects what you've programmed. You can always program frequencies to blank channels regardless of this setting.

1. "onProtCt" is displayed on the LCD.
2. Rotate the dial to switch ON/OFF the Memory Write Protect function as follows:

"onProtCt" -> "offProtCt"

Caution

Note that when you reset all settings (see on P.30) when the transceiver is set to "offProtCt", which allows it to overwrite, ALL memory channels you programmed are deleted.

The factory-shipped default is set to "onProtCt" which prevents deleting memories by performing a reset. Be mindful about this parameter when you reset the transceiver.

(9) Scan Type

You can select the scan-resume condition between Busy scan and Timer scan.

1. "bUSY" is displayed on the LCD.
2. Rotate the dial to switch the scan-resume condition as follows:

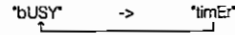

(10) AM / FM

You can select the modulation reception mode between AM and FM.

It is necessary to set a tuning step other than "Auto" in advance. For more information on this, please refer to "Entry Completion Digit for Different Tuning Steps" on P.15.

1. "aRUE" is displayed on the LCD.
2. Rotate the dial to switch between AM and FM.

Tip

When you set a tuning step to "Auto", you are not able to switch the modulation mode. In this case, you will see "-----" displayed on the LCD.

7. Cloning

7.1 Cloning

With the Cloning function, it is possible to connect two transceivers with a cable, and copy all settings from one unit (called the Master) to the other (called the Slave). This function transfers all the settings of the Master including memory channel data.

Connecting the Transceiver

- Connect both of the speaker jacks on the sending transceiver (Master side) and the receiving transceiver (Slave side) with a ø 2.5 stereo mini-plug cord as shown in the below illustration.
- Be sure that both transceivers are switched OFF before connecting them.

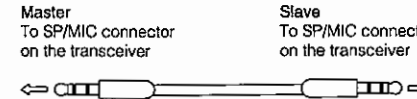

Receiving the Master Data

Here are the operations of the Slave side.

1. While holding the MONI key down, turn the power ON. "CLonE" is displayed on the LCD, and the Slave enters the Clone mode.

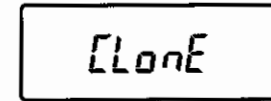

2. Wait for a while until the master data is transferred completely.

For more information on sending the master data, please refer to the next section.

3. Turn the power OFF on the Slave.

- The stereo mini-plug cord should be direct-coupled to avoid internal resistance.
- Even while the DJ-C6 transfers data, the operation can be suspended with any key operations. To restart transferring, press the PTT key.
- Do not disconnect the cable while cloning. When the cord is disconnected, "FRiL" is displayed on the Master's LCD, and the DJ-C6 suspends transferring.
- All data in the slave side will be overwritten if cloning is executed. Be careful with current data on the Slave before cloning.

Transmitting Data from the Master Transceiver

Here are the operations of the Master side.

1. While holding the MONI key down, turn the power ON. "CLonE" is displayed on the LCD, and the Master enters the Clone mode.



2. Press the dial.

"Sd 00" is displayed on the LCD, and the Master starts to transfer data.

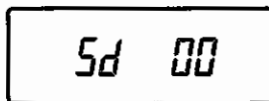

"F in SH" is displayed on the LCD when transfer is completed successfully.

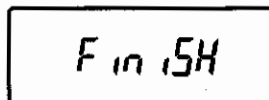

3. Turn the power OFF on the Master side to release the Clone mode.

If the DJ-C6 should fail to transfer data, "FR L" is displayed on the LCD. If you see this indicator, redo from step 1.

7

Cloning

8. Maintenance and Reference

8.1 Troubleshooting

Please check the list below before concluding that the transceiver is faulty. If a problem persists, reset the transceiver. This may correct erroneous operations.

Symptom	Possible Cause	Action
Nothing appears on the display when you turn the power on.	Poor Li-ion battery pack connection	Check if the battery pack terminals are clean.
	Battery is discharged.	Recharge the battery pack.
	You are releasing the key too quickly.	Hold the power switch down for 1 second.
No speaker audio. No reception.	Volume too low.	Adjust the audio level.
	Squelch level too high.	Adjust the squelch.
	Tone squelch is on.	Turn off tone squelch.
	You are pressing the PTT key and transmitting.	Release the PTT key.
Frequency display is incorrect.	CPU error.	Remove the battery pack or external power supply, wait 10 seconds and attach it again. If it is still not operating, reset the transceiver.
Won't scan.	Squelch is unmuted.	Set squelch so that noise is just muted.
Frequency and memory number do not change.	Keylock is on.	Turn off keylock.
Key entry not possible.	Keylock is on.	Turn off keylock.
One-touch repeater cannot be used.	Incorrect setting for one-touch repeater use.	Set the transceiver correctly for repeater use.
Cannot transmit. Display blinks or goes out when you transmit.	Battery power is insufficient.	Recharge the battery pack.
Cannot transmit. No reply when you transmit.	Not pressing the PTT key firmly enough.	Press the PTT key firmly.
	You are outside of the band.(when shift is set.)	Transmit within transmission frequency range.
	Incorrect frequency.	Match your frequency to receiving station's frequency.
Display blinks or goes out when you receive.	Battery power is insufficient.	Recharge the battery pack.

8

Maintenance and Reference

8.2 Resetting

When you reset the transceiver, all settings are returned to the initial (default) factory setting. Please be aware that the memory data will be deleted also when the write protect setting is off.

1. Press and hold the **FUNC** key and press the **Power** key to turn the power on.

2. Release the keys when all icons are displayed. The transceiver returns to the initial VFO mode.

● Factory Setting

- VFO Frequency
 - VHF :145.000MHz
 - L-UHF :380.000MHz (T version)
 - UHF :445.000MHz (T version)
 - UHF :439.000MHz (E version)
 - Air :118.000MHz (T version)
- Memory Channel 0 - 199ch blank
- Audio Volume 10
- Squelch Level 3
- Battery Save ON
- Scan Resume Condition Busy Scan
- Beep ON
- Tuning Step Auto
- Shift OFF
- Shift Range
 - VHF :0.6MHz
 - UHF :5.0MHz
- Tone Squelch OFF
- Tone Frequency 88.5Hz
- APO, BELL OFF

8.3 Options

- | | |
|-------------|-------------------------------------|
| EBP-58N | Li-ion battery pack (DC3.7V 600mAh) |
| EDC-126/128 | AC battery charger |
| EDH-32 | Cigarette lighter cable |
| EME-18 | Earphone |
| EME-24 | Earphone microphone |
| EMS-60 | Speaker microphone |
| ESC-38 | Soft case |

8.4 Transmission System

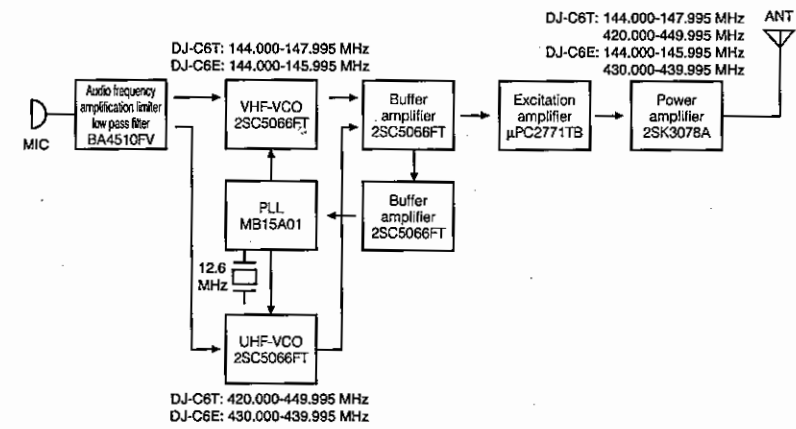

9. Specifications

●General

TX Frequency Range	VHF	144.000 ~ 147.995MHz (T version) 144.000 ~ 145.995MHz (E version)
	UHF	420.000 ~ 449.995MHz (T version) 430.000 ~ 439.995MHz (E version)
RX Frequency Range	VHF	108.000 ~ 173.995MHz (T version) 144.000 ~ 145.995MHz (E version)
	UHF	380.000 ~ 511.995MHz (T version) 430.000 ~ 439.995MHz (E version)
Modulation	F3E	
Antenna Impedance	50 ohm (SMA)	
Rated Voltage	External Terminal	3.7 ~ 6.0 VDC
	Battery Terminal	3.7 VDC
Current	Transmit	DC6.0V: VHF Approx. 0.28A, UHF Approx. 0.32A 3.7V (EBP-58N): VHF Approx. 0.25A, UHF Approx. 0.30A
	Receive	Approx. 70mA
	Battery Save	Approx. 19mA
Frequency Stability	-7 ~ +3 ppm (-10 ~ 60°C)	
Dimensions (Projection exclusive)	58(W) x 96(H) x 14.5(D) mm	
Weight	Approx. 102g (EBP-58N inclusive)	

●Transmitter

Power Output	DC6.0V	Approx. 0.5W
	EBP-58N	Approx. 0.3W
Modulation	Variable Reactance	
Maximum Deviation	+/- 5kHz	
Spurious Emission	-60dB or less	
Microphone Impedance	Approx. 2.2 kohm	

●Receiver

System	Double-conversion super heterodyne	
Intermediate Frequency	1st	IF 50.85MHz (AM/FM)
	2nd	IF 450kHz (AM/FM)
Sensitivity	(12dB SINAD)	-15.0dBu or less
Selectivity	-6dB	12kHz or over (AM/FM)
	-60dB	35kHz or over (AM/FM)
Audio Output	100mW or over (MAX)	
Spurious Response	90mW or over (10% Distortion factor 8 ohm)	
Squelch Sensitivity	60dB or over	
	Approx. -16dBu or less	